

# ***Sentry LST***

Convactor heating



| <b>Contents</b>          | <b>Page</b> |
|--------------------------|-------------|
| General information      | 1           |
| Technical Data           | 2           |
| Dimensions               | 2           |
| Emission rates           | 3 - 6       |
| Connection configuration | 7           |
| Installation             | 8 - 9       |

Engineering Data Sheet 811/1

January 2010



## General information

---

### Manufacture

Clyde Sentry Low Surface Temperature heat emitters combine a steel and aluminium finned convactor with a one piece flat steel cover and top grill finished in RAL 9010 white. Pipework connection size is R½ Flow and Return. A wide range of pipework connection options are available to suit any application (see page 7), and there is a choice of thermostatic controls for the combination valve (see below). The Sentry is designed for use with LTHW with a maximum flow temperature of 90°C and a maximum allowable pressure of 6 bar. The convactor heat exchanger itself is suitable for MTHW with a maximum flow temperature of 130°C and 10 bar pressure rating is available to special order.

A convactor is especially suitable for this type of emitter, where heat exchange by convection is more desirable than radiation. Typically, covering a radiator and so restricting radiant heat transfer will reduce heat emissions by up to 60% (NHS Estates Health Guidance Note 'Safe' hot water and surface temperatures, 1998).

The one-piece cover is manufactured from 1mm electrolytically galvanised steel to EN 101052 and polyester/epoxy powder coated for a high quality finish. It is easy to clean and a poor harbour for dust and micro-organisms.

### Application

These heat emitters provide protection against physical contact with hot surfaces and consequential burning. They will assist an employer to meet his legal duty of care in respect of the risk of scalding and burning from hot water and hot surfaces.

### Testing

Clyde Sentry LSTs are tested in accordance with BS EN 442-1:1995. As required by this standard, emission rates are quoted for the standard thermal output of dT50 (Flow temperature 75°C / Return temperature 65°C / Room temperature 20°C) with the relevant exponent of excess temperature (1.42).

### Guarantee

Subject to correct handling, installation and operation in accordance with manufacturer's instructions, Clyde Sentry heat emitters are guaranteed for a period of five years from the date of delivery.



### Thermostatic radiator valves and controls

The Herz combination valve, shown below, is the standard configuration valve offered by Clyde (see pages 2 and 7). The standard valve from Clyde is for 2-pipe systems. A 1-pipe system valve is available to special order. The Herz valve is exceptionally versatile with connections for copper, steel or plastic pipe. Pipe connections are nominal 15mm.

A choice of four alternative valve heads are available for the combination valve and are shown below;

- Herz standard TRV valve head
- Herzcules anti-tamper TRV valve head
- Herz TRV valve with a remote sensing bulb
- Herz T5 manual wheelhead if thermostatic control is not required



Standard Herz valve for 2-pipe system, shown with T5 manual wheelhead



Standard TRV valve



Anti-tamper TRV valve



Remote TRV valve

# Dimensions & Technical Data

## Sentry LST Heat Emitter Dimensions

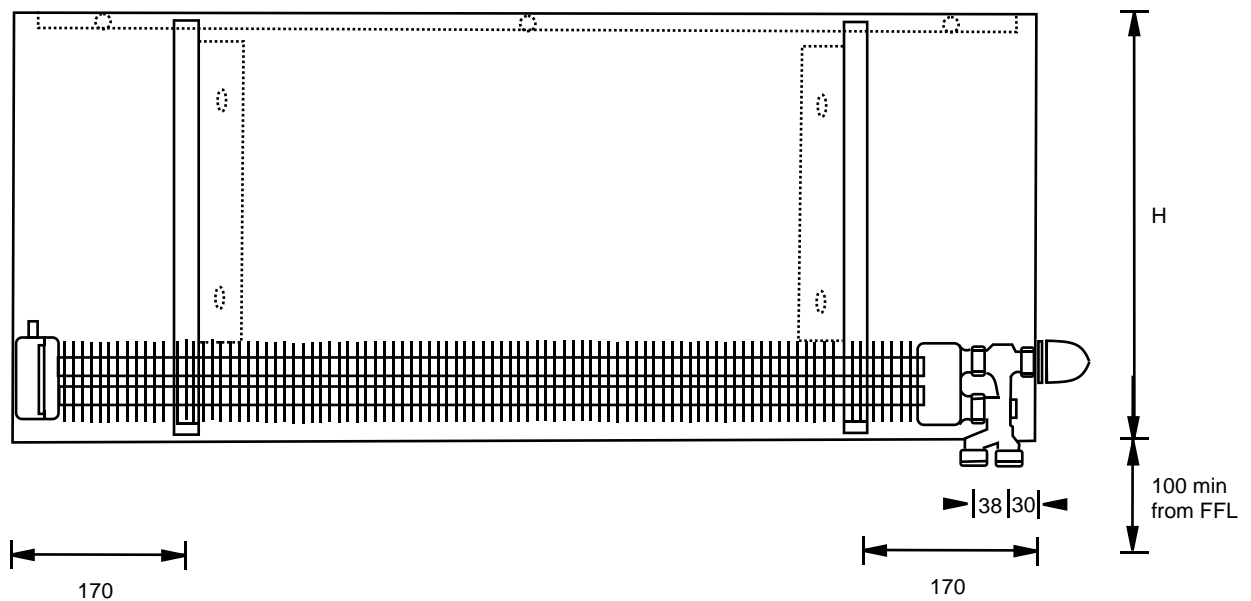

Fig 1 Sentry dimensions in mm, including pipe centres for Herz 2-pipe system valve. For height 'H' refer to data tables on pages 3 to 6

| Sentry depth | Dimension A (mm) |
|--------------|------------------|
| 80           | 42.5             |
| 125          | 65               |
| 175          | 90               |
| 225          | 115              |
| 275          | 140              |

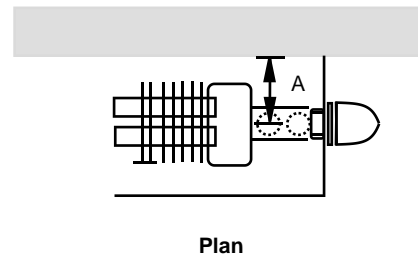

Fig 2 Distance of pipe centre from wall (dimension 'A') for each Sentry model

### Heat emission rates

For convenience, the emission rates are quoted for typical United Kingdom applications of  $dT_{55.5}$  (82/71/21°C) and  $dT_{60}$  (90/70/20°C) in addition to the BS EN 442-1 conditions of  $dT_{50}$ . Different water or room temperatures will change the emission rate of a radiator. The method of calculation and correction factors for various temperatures are given in the Clyde radiator emission guide EDS 732, available on request. The emission rates and exponent of excess temperature are specific to a convection-only heat exchanger.

### Radiator selection

The Sentry is available in an extensive range of sizes and outputs that make it suitable for almost any application;

- 6 heights from 200mm to 800mm
- 5 depths from 80mm to 275mm.
- 16 standard lengths from 400mm to 2600mm. Other lengths up to a maximum of 2600 are available to special order.
- The standard connection configuration is TBSE (Top Bottom Same End) is illustrated in fig 1, which permits the use of the Herz radiator valve with the choice of thermostatic controls shown on page 1. If one of the other connection configurations shown on page 7 is selected, Clyde can offer a suitable choice of valve. A special 'change-fix' spanner is available from Clyde for Herz valves.
- A cut-out in the casing for the valve head is provided bottom right as standard. Alternative positions are bottom left, top right or top left (for the remote sensing valve) or no cut-out (for bottom entry connections)

Further information on radiator selection and model designation is given on page 3.

## Dimensions & Technical Data

### Radiator models and codes

The following tables give outputs for each model height and at 3 popular dTs in each shaded column for easy reference. The first column gives the model reference (see below) and the second column gives the standard length and depth. Bespoke lengths are available to special order to perfectly match any application.

The model designation in the left hand column is an amalgamation of the model name, length, depth and height, and 'H' should be suffixed with the required height. To illustrate;

SENT4027H3

SENT = Sentry

40 = 400 Long

27 = 275 Deep

H3 = 300 High

#### To select your Sentry LST;

- ✓ Select model, height, length, depth and output as above
- ✓ Select the valve connection configuration from page 7. If no preference is stated, standard configuration B (TBSE) will be supplied.
- ✓ Select the optionally available valve and TRV valve head from page 1.
- ✓ Select the casing cut-out as page 2. If no preference is stated, a standard bottom right cut-out will be supplied.

| Model     | Length mm | Depth mm | Height and Output (w) |        |      |                |        |      |                |        |      |
|-----------|-----------|----------|-----------------------|--------|------|----------------|--------|------|----------------|--------|------|
|           |           |          | Height = 200mm        |        |      | Height = 300mm |        |      | Height = 400mm |        |      |
|           |           |          | dT50                  | dT55.5 | dT60 | dT50           | dT55.5 | dT60 | dT50           | dT55.5 | dT60 |
| SENT4008H | 400       | 80       | 165                   | 191    | 216  | 187            | 217    | 240  | 212            | 246    | 274  |
| SENT4012H | 400       | 125      | 283                   | 328    | 372  | 341            | 396    | 437  | 393            | 456    | 506  |
| SENT4017H | 400       | 175      | 396                   | 459    | 520  | 489            | 567    | 640  | 565            | 655    | 734  |
| SENT4022H | 400       | 225      | 536                   | 622    | 703  | 655            | 760    | 861  | 747            | 867    | 976  |
| SENT4027H | 400       | 275      | 651                   | 755    | 852  | 810            | 940    | 1064 | 930            | 1079   | 1213 |
| SENT5008H | 500       | 80       | 207                   | 240    | 271  | 234            | 271    | 300  | 266            | 309    | 342  |
| SENT5012H | 500       | 125      | 354                   | 411    | 465  | 426            | 494    | 547  | 491            | 570    | 633  |
| SENT5017H | 500       | 175      | 495                   | 574    | 651  | 612            | 710    | 801  | 706            | 819    | 918  |
| SENT5022H | 500       | 225      | 671                   | 778    | 879  | 819            | 950    | 1076 | 934            | 1083   | 1220 |
| SENT5027H | 500       | 275      | 814                   | 944    | 1066 | 1012           | 1174   | 1330 | 1162           | 1348   | 1517 |
| SENT6008H | 600       | 80       | 248                   | 288    | 325  | 280            | 325    | 359  | 319            | 370    | 410  |
| SENT6012H | 600       | 125      | 424                   | 492    | 557  | 511            | 593    | 656  | 589            | 683    | 760  |
| SENT6017H | 600       | 175      | 594                   | 689    | 781  | 734            | 851    | 961  | 847            | 983    | 1102 |
| SENT6022H | 600       | 225      | 805                   | 934    | 1055 | 982            | 1139   | 1291 | 1121           | 1300   | 1463 |
| SENT6027H | 600       | 275      | 976                   | 1132   | 1279 | 1214           | 1408   | 1596 | 1394           | 1617   | 1820 |
| SENT7008H | 700       | 80       | 289                   | 335    | 379  | 327            | 379    | 419  | 372            | 432    | 479  |
| SENT7012H | 700       | 125      | 495                   | 574    | 650  | 596            | 691    | 765  | 687            | 797    | 886  |
| SENT7017H | 700       | 175      | 693                   | 804    | 911  | 856            | 993    | 1121 | 988            | 1146   | 1285 |
| SENT7022H | 700       | 225      | 939                   | 1089   | 1231 | 1146           | 1329   | 1506 | 1308           | 1517   | 1707 |
| SENT7027H | 700       | 275      | 1139                  | 1321   | 1492 | 1417           | 1644   | 1862 | 1627           | 1887   | 2123 |
| SENT8008H | 800       | 80       | 330                   | 383    | 433  | 374            | 434    | 479  | 425            | 493    | 547  |
| SENT8012H | 800       | 125      | 566                   | 657    | 743  | 682            | 791    | 874  | 786            | 912    | 1013 |
| SENT8017H | 800       | 175      | 792                   | 919    | 1041 | 978            | 1134   | 1281 | 1130           | 1311   | 1469 |
| SENT8022H | 800       | 225      | 1073                  | 1245   | 1406 | 1310           | 1520   | 1722 | 1494           | 1733   | 1951 |
| SENT8027H | 800       | 275      | 1302                  | 1510   | 1705 | 1619           | 1878   | 2128 | 1859           | 2156   | 2426 |
| SENT9008H | 900       | 80       | 372                   | 432    | 487  | 420            | 487    | 539  | 478            | 554    | 616  |
| SENT9012H | 900       | 125      | 636                   | 738    | 836  | 767            | 890    | 984  | 884            | 1025   | 1139 |
| SENT9017H | 900       | 175      | 891                   | 1034   | 1171 | 1101           | 1277   | 1441 | 1271           | 1474   | 1652 |
| SENT9022H | 900       | 225      | 1207                  | 1400   | 1582 | 1473           | 1709   | 1937 | 1681           | 1950   | 2195 |
| SENT9027H | 900       | 275      | 1464                  | 1698   | 1918 | 1822           | 2114   | 2394 | 2092           | 2427   | 2730 |
| SENT1008H | 1000      | 80       | 413                   | 479    | 541  | 467            | 542    | 599  | 531            | 616    | 684  |
| SENT1012H | 1000      | 125      | 707                   | 820    | 929  | 852            | 988    | 1093 | 982            | 1139   | 1266 |
| SENT1017H | 1000      | 175      | 990                   | 1148   | 1301 | 1223           | 1419   | 1601 | 1412           | 1638   | 1836 |
| SENT1022H | 1000      | 225      | 1341                  | 1556   | 1758 | 1637           | 1899   | 2152 | 1868           | 2167   | 2439 |
| SENT1027H | 1000      | 275      | 1627                  | 1887   | 2131 | 2024           | 2348   | 2660 | 2324           | 2696   | 3033 |
| SENT1108H | 1100      | 80       | 454                   | 527    | 595  | 514            | 596    | 659  | 584            | 677    | 752  |
| SENT1112H | 1100      | 125      | 778                   | 902    | 1022 | 937            | 1087   | 1202 | 1080           | 1253   | 1393 |
| SENT1117H | 1100      | 175      | 1089                  | 1263   | 1431 | 1345           | 1560   | 1761 | 1553           | 1801   | 2020 |
| SENT1122H | 1100      | 225      | 1475                  | 1711   | 1934 | 1801           | 2089   | 2367 | 2055           | 2384   | 2683 |
| SENT1127H | 1100      | 275      | 1790                  | 2076   | 2344 | 2226           | 2582   | 2926 | 2294           | 2661   | 3014 |

## Dimensions & Technical Data

| Model     | Length mm | Depth mm | Height and Output (w) |        |      |                |        |      |                |        |      |
|-----------|-----------|----------|-----------------------|--------|------|----------------|--------|------|----------------|--------|------|
|           |           |          | Height = 500mm        |        |      | Height = 600mm |        |      | Height = 800mm |        |      |
|           |           |          | dT50                  | dT55.5 | dT60 | dT50           | dT55.5 | dT60 | dT50           | dT55.5 | dT60 |
| SENT4008H | 400       | 80       | 238                   | 276    | 308  | 246            | 285    | 317  | 271            | 314    | 344  |
| SENT4012H | 400       | 125      | 445                   | 516    | 576  | 466            | 541    | 600  | 510            | 592    | 646  |
| SENT4017H | 400       | 175      | 628                   | 728    | 811  | 682            | 791    | 878  | 770            | 893    | 984  |
| SENT4022H | 400       | 225      | 821                   | 952    | 1064 | 881            | 1022   | 1137 | 971            | 1126   | 1240 |
| SENT4027H | 400       | 275      | 1035                  | 1201   | 1342 | 1091           | 1266   | 1407 | 1188           | 1378   | 1516 |
| SENT5008H | 500       | 80       | 298                   | 346    | 386  | 308            | 357    | 396  | 339            | 393    | 430  |
| SENT5012H | 500       | 125      | 556                   | 645    | 720  | 583            | 676    | 750  | 637            | 739    | 808  |
| SENT5017H | 500       | 175      | 785                   | 911    | 1014 | 853            | 989    | 1098 | 962            | 1116   | 1230 |
| SENT5022H | 500       | 225      | 1027                  | 1191   | 1331 | 1102           | 1278   | 1421 | 1214           | 1408   | 1550 |
| SENT5027H | 500       | 275      | 1294                  | 1501   | 1677 | 1364           | 1582   | 1759 | 1486           | 1724   | 1896 |
| SENT6008H | 600       | 80       | 358                   | 415    | 463  | 370            | 429    | 475  | 407            | 472    | 516  |
| SENT6012H | 600       | 125      | 667                   | 774    | 864  | 700            | 812    | 900  | 764            | 886    | 970  |
| SENT6017H | 600       | 175      | 942                   | 1093   | 1217 | 1023           | 1187   | 1317 | 1154           | 1339   | 1475 |
| SENT6022H | 600       | 225      | 1232                  | 1429   | 1597 | 1322           | 1534   | 1705 | 1456           | 1689   | 1859 |
| SENT6027H | 600       | 275      | 1553                  | 1801   | 2012 | 1636           | 1898   | 2111 | 1783           | 2068   | 2275 |
| SENT7008H | 700       | 80       | 417                   | 484    | 540  | 431            | 500    | 554  | 475            | 551    | 602  |
| SENT7012H | 700       | 125      | 778                   | 902    | 1008 | 816            | 947    | 1050 | 892            | 1035   | 1131 |
| SENT7017H | 700       | 175      | 1099                  | 1275   | 1420 | 1194           | 1385   | 1537 | 1347           | 1563   | 1721 |
| SENT7022H | 700       | 225      | 1437                  | 1667   | 1863 | 1542           | 1789   | 1989 | 1699           | 1971   | 2169 |
| SENT7027H | 700       | 275      | 1812                  | 2102   | 2348 | 1909           | 2214   | 2463 | 2080           | 2413   | 2654 |
| SENT8008H | 800       | 80       | 477                   | 553    | 617  | 493            | 572    | 634  | 542            | 629    | 688  |
| SENT8012H | 800       | 125      | 890                   | 1032   | 1152 | 933            | 1082   | 1200 | 1019           | 1182   | 1293 |
| SENT8017H | 800       | 175      | 1256                  | 1457   | 1622 | 1364           | 1582   | 1756 | 1539           | 1785   | 1967 |
| SENT8022H | 800       | 225      | 1642                  | 1905   | 2129 | 1762           | 2044   | 2274 | 1942           | 2253   | 2479 |
| SENT8027H | 800       | 275      | 2070                  | 2401   | 2683 | 2182           | 2531   | 2814 | 2377           | 2757   | 3033 |
| SENT9008H | 900       | 80       | 536                   | 622    | 694  | 554            | 643    | 713  | 610            | 708    | 774  |
| SENT9012H | 900       | 125      | 1001                  | 1161   | 1296 | 1049           | 1217   | 1350 | 1147           | 1331   | 1454 |
| SENT9017H | 900       | 175      | 1413                  | 1639   | 1825 | 1535           | 1781   | 1976 | 1732           | 2009   | 2213 |
| SENT9022H | 900       | 225      | 1848                  | 2144   | 2395 | 1983           | 2300   | 2558 | 2184           | 2533   | 2789 |
| SENT9027H | 900       | 275      | 2329                  | 2702   | 3019 | 2454           | 2847   | 3166 | 2674           | 3102   | 3412 |
| SENT1008H | 1000      | 80       | 596                   | 691    | 771  | 616            | 715    | 792  | 678            | 786    | 860  |
| SENT1012H | 1000      | 125      | 1112                  | 1290   | 1440 | 1166           | 1353   | 1500 | 1274           | 1478   | 1616 |
| SENT1017H | 1000      | 175      | 1570                  | 1821   | 2028 | 1705           | 1978   | 2195 | 1924           | 2232   | 2459 |
| SENT1022H | 1000      | 225      | 2053                  | 2381   | 2661 | 2203           | 2555   | 2842 | 2427           | 2815   | 3099 |
| SENT1027H | 1000      | 275      | 2588                  | 3002   | 3354 | 2727           | 3163   | 3518 | 2971           | 3446   | 3791 |
| SENT1108H | 1100      | 80       | 656                   | 761    | 848  | 678            | 786    | 871  | 746            | 865    | 946  |
| SENT1112H | 1100      | 125      | 1223                  | 1419   | 1584 | 1283           | 1488   | 1650 | 1401           | 1625   | 1778 |
| SENT1117H | 1100      | 175      | 1727                  | 2003   | 2231 | 1876           | 2176   | 2415 | 2116           | 2455   | 2705 |
| SENT1122H | 1100      | 225      | 2258                  | 2619   | 2927 | 2423           | 2811   | 3126 | 2670           | 3097   | 3409 |
| SENT1127H | 1100      | 275      | 2847                  | 3303   | 3689 | 3000           | 3480   | 3870 | 3268           | 3791   | 4170 |

## Dimensions & Technical Data

### Radiator models and codes

The following tables give outputs for each model height and at 3 popular dTs in each shaded column for easy reference. The first column gives the model reference (see below) and the second column gives the standard length and depth. Bespoke lengths are available to special order to perfectly match any application.

The model designation in the left hand column is an amalgamation of the model name, length, depth and height, and 'H' should be suffixed with the required height. To illustrate;

SENT4027H3

SENT = Sentry

40 = 400 Long

27 = 275 Deep

H3 = 300 High

#### To select your Sentry LST;

- ✓ Select model, height, length, depth and output as above
- ✓ Select the valve connection configuration from page 7. If no preference is stated, standard configuration B (TBSE) will be supplied.
- ✓ Select the optionally available valve and TRV valve head from page 1.
- ✓ Select the casing cut-out as page 2. If no preference is stated, a standard bottom right cut-out will be supplied.

| Model     | Length mm | Depth mm | Height and Output (w) |        |      |                |        |      |                |        |      |
|-----------|-----------|----------|-----------------------|--------|------|----------------|--------|------|----------------|--------|------|
|           |           |          | Height = 200mm        |        |      | Height = 300mm |        |      | Height = 400mm |        |      |
|           |           |          | dT50                  | dT55.5 | dT60 | dT50           | dT55.5 | dT60 | dT50           | dT55.5 | dT60 |
| SENT1208H | 1200      | 80       | 496                   | 575    | 649  | 560            | 650    | 719  | 637            | 739    | 821  |
| SENT1212H | 1200      | 125      | 848                   | 984    | 1115 | 1022           | 1186   | 1312 | 1178           | 1366   | 1519 |
| SENT1217H | 1200      | 175      | 1188                  | 1378   | 1561 | 1468           | 1703   | 1921 | 1694           | 1965   | 2203 |
| SENT1222H | 1200      | 225      | 1609                  | 1866   | 2110 | 1964           | 2278   | 2582 | 2242           | 2601   | 2927 |
| SENT1227H | 1200      | 275      | 1952                  | 2264   | 2557 | 2429           | 2818   | 3193 | 2789           | 3235   | 3640 |
| SENT1408H | 1400      | 80       | 578                   | 670    | 757  | 654            | 759    | 839  | 743            | 862    | 958  |
| SENT1412H | 1400      | 125      | 990                   | 1148   | 1301 | 1193           | 1384   | 1530 | 1375           | 1595   | 1772 |
| SENT1417H | 1400      | 175      | 1386                  | 1608   | 1821 | 1712           | 1986   | 2241 | 1977           | 2293   | 2570 |
| SENT1422H | 1400      | 225      | 1877                  | 2177   | 2461 | 2292           | 2659   | 3013 | 2615           | 3033   | 3415 |
| SENT1427H | 1400      | 275      | 2278                  | 2642   | 2983 | 2834           | 3287   | 3724 | 3254           | 3775   | 4246 |
| SENT1608H | 1600      | 80       | 661                   | 767    | 866  | 747            | 867    | 958  | 850            | 986    | 1094 |
| SENT1612H | 1600      | 125      | 1131                  | 1312   | 1486 | 1363           | 1581   | 1749 | 1571           | 1822   | 2026 |
| SENT1617H | 1600      | 175      | 1584                  | 1837   | 2082 | 1957           | 2270   | 2562 | 2259           | 2620   | 2938 |
| SENT1622H | 1600      | 225      | 2146                  | 2489   | 2813 | 2619           | 3038   | 3443 | 2989           | 3467   | 3902 |
| SENT1627H | 1600      | 275      | 2603                  | 3019   | 3410 | 3238           | 3756   | 4256 | 3718           | 4313   | 4853 |
| SENT1808H | 1800      | 80       | 743                   | 862    | 974  | 841            | 976    | 1078 | 956            | 1109   | 1231 |
| SENT1812H | 1800      | 125      | 1273                  | 1477   | 1672 | 1534           | 1779   | 1967 | 1768           | 2051   | 2279 |
| SENT1817H | 1800      | 175      | 1782                  | 2067   | 2342 | 2201           | 2553   | 2882 | 2542           | 2949   | 3305 |
| SENT1822H | 1800      | 225      | 2414                  | 2800   | 3164 | 2947           | 3419   | 3874 | 3362           | 3900   | 4390 |
| SENT1827H | 1800      | 275      | 2929                  | 3398   | 3836 | 3643           | 4226   | 4788 | 4183           | 4852   | 5459 |
| SENT2008H | 2000      | 80       | 826                   | 958    | 1082 | 934            | 1083   | 1198 | 1062           | 1232   | 1368 |
| SENT2012H | 2000      | 125      | 1414                  | 1640   | 1858 | 1704           | 1977   | 2186 | 1964           | 2278   | 2532 |
| SENT2017H | 2000      | 175      | 1980                  | 2297   | 2602 | 2446           | 2837   | 3202 | 2824           | 3276   | 3672 |
| SENT2022H | 2000      | 225      | 2682                  | 3111   | 3516 | 3274           | 3798   | 4304 | 3736           | 4334   | 4878 |
| SENT2027H | 2000      | 275      | 3254                  | 3775   | 4262 | 4048           | 4696   | 5320 | 4648           | 5392   | 6066 |
| SENT2208H | 2200      | 80       | 909                   | 1054   | 1190 | 1027           | 1191   | 1318 | 1168           | 1355   | 1505 |
| SENT2212H | 2200      | 125      | 1555                  | 1804   | 2044 | 1874           | 2174   | 2405 | 2160           | 2506   | 2785 |
| SENT2217H | 2200      | 175      | 2178                  | 2526   | 2862 | 2691           | 3122   | 3522 | 3106           | 3603   | 4039 |
| SENT2222H | 2200      | 225      | 2950                  | 3422   | 3868 | 3601           | 4177   | 4734 | 4110           | 4768   | 5366 |
| SENT2227H | 2200      | 275      | 3579                  | 4152   | 4688 | 4453           | 5165   | 5852 | 5113           | 5931   | 6673 |
| SENT2408H | 2400      | 80       | 991                   | 1150   | 1298 | 1121           | 1300   | 1438 | 1274           | 1478   | 1642 |
| SENT2412H | 2400      | 125      | 1697                  | 1969   | 2230 | 2045           | 2372   | 2623 | 2357           | 2734   | 3038 |
| SENT2417H | 2400      | 175      | 2376                  | 2756   | 3122 | 2935           | 3405   | 3842 | 3389           | 3931   | 4406 |
| SENT2422H | 2400      | 225      | 3218                  | 3733   | 4219 | 3929           | 4558   | 5165 | 4483           | 5200   | 5854 |
| SENT2427H | 2400      | 275      | 3905                  | 4530   | 5114 | 4858           | 5635   | 6384 | 5578           | 6470   | 7279 |
| SENT2608H | 2600      | 80       | 1074                  | 1246   | 1407 | 1214           | 1408   | 1557 | 1381           | 1602   | 1778 |
| SENT2612H | 2600      | 125      | 1838                  | 2132   | 2415 | 2215           | 2569   | 2842 | 2553           | 2961   | 3292 |
| SENT2617H | 2600      | 175      | 2574                  | 2986   | 3383 | 3180           | 3689   | 4163 | 3671           | 4258   | 4774 |

## Dimensions & Technical Data

| Model     | Length mm | Depth mm | Height and Output (w) |        |      |                |        |      |                |        |      |
|-----------|-----------|----------|-----------------------|--------|------|----------------|--------|------|----------------|--------|------|
|           |           |          | Height =500mm         |        |      | Height = 600mm |        |      | Height = 800mm |        |      |
|           |           |          | dT50                  | dT55.5 | dT60 | dT50           | dT55.5 | dT60 | dT50           | dT55.5 | dT60 |
| SENT1208H | 1200      | 80       | 715                   | 829    | 925  | 739            | 829    | 950  | 814            | 829    | 1032 |
| SENT1212H | 1200      | 125      | 1334                  | 1547   | 1728 | 1399           | 1547   | 1800 | 1529           | 1547   | 1939 |
| SENT1217H | 1200      | 175      | 1884                  | 2185   | 2434 | 2046           | 2185   | 2634 | 2309           | 2185   | 2951 |
| SENT1222H | 1200      | 225      | 2464                  | 2858   | 3193 | 2644           | 2858   | 3410 | 2912           | 2858   | 3719 |
| SENT1227H | 1200      | 275      | 3106                  | 3603   | 4025 | 3272           | 3603   | 4222 | 3565           | 3603   | 4549 |
| SENT1408H | 1400      | 80       | 834                   | 967    | 1079 | 862            | 967    | 1109 | 949            | 967    | 1204 |
| SENT1412H | 1400      | 125      | 1557                  | 1806   | 2016 | 1632           | 1806   | 2100 | 1784           | 1806   | 2262 |
| SENT1417H | 1400      | 175      | 2198                  | 2550   | 2839 | 2387           | 2550   | 3073 | 2694           | 2550   | 3443 |
| SENT1422H | 1400      | 225      | 2874                  | 3334   | 3725 | 3084           | 3334   | 3979 | 3398           | 3334   | 4339 |
| SENT1427H | 1400      | 275      | 3623                  | 4203   | 4696 | 3818           | 4203   | 4925 | 4159           | 4203   | 5307 |
| SENT1608H | 1600      | 80       | 954                   | 1107   | 1234 | 986            | 1107   | 1267 | 1085           | 1107   | 1376 |
| SENT1612H | 1600      | 125      | 1779                  | 2064   | 2304 | 1866           | 2064   | 2400 | 2038           | 2064   | 2586 |
| SENT1617H | 1600      | 175      | 2512                  | 2914   | 3245 | 2728           | 2914   | 3512 | 3078           | 2914   | 3934 |
| SENT1622H | 1600      | 225      | 3285                  | 3811   | 4258 | 3525           | 3811   | 4547 | 3883           | 3811   | 4958 |
| SENT1627H | 1600      | 275      | 4141                  | 4804   | 5366 | 4363           | 4804   | 5629 | 4754           | 4804   | 6066 |
| SENT1808H | 1800      | 80       | 1073                  | 1245   | 1388 | 1109           | 1245   | 1426 | 1220           | 1245   | 1548 |
| SENT1812H | 1800      | 125      | 2002                  | 2322   | 2592 | 2099           | 2322   | 2700 | 2293           | 2322   | 2909 |
| SENT1817H | 1800      | 175      | 2826                  | 3278   | 3650 | 3069           | 3278   | 3951 | 3463           | 3278   | 4426 |
| SENT1822H | 1800      | 225      | 3695                  | 4286   | 4790 | 3965           | 4286   | 5116 | 4369           | 4286   | 5578 |
| SENT1827H | 1800      | 275      | 4658                  | 5403   | 6037 | 4909           | 5403   | 6332 | 5348           | 5403   | 6824 |
| SENT2008H | 2000      | 80       | 1192                  | 1383   | 1542 | 1232           | 1383   | 1584 | 1356           | 1383   | 1720 |
| SENT2012H | 2000      | 125      | 2224                  | 2580   | 2880 | 2332           | 2580   | 3000 | 2548           | 2580   | 3232 |
| SENT2017H | 2000      | 175      | 3140                  | 3642   | 4056 | 3410           | 3642   | 4390 | 3848           | 3642   | 4918 |
| SENT2022H | 2000      | 225      | 4106                  | 4763   | 5322 | 4406           | 4763   | 5684 | 4854           | 4763   | 6198 |
| SENT2027H | 2000      | 275      | 5176                  | 6004   | 6708 | 5454           | 6004   | 7036 | 5942           | 6004   | 7582 |
| SENT2208H | 2200      | 80       | 1311                  | 1521   | 1696 | 1355           | 1521   | 1742 | 1492           | 1521   | 1892 |
| SENT2212H | 2200      | 125      | 2446                  | 2837   | 3168 | 2565           | 2837   | 3300 | 2803           | 2837   | 3555 |
| SENT2217H | 2200      | 175      | 3454                  | 4007   | 4462 | 3751           | 4007   | 4829 | 4233           | 4007   | 5410 |
| SENT2222H | 2200      | 225      | 4517                  | 5240   | 5854 | 4847           | 5240   | 6252 | 5339           | 5240   | 6818 |
| SENT2227H | 2200      | 275      | 5694                  | 6605   | 7379 | 5999           | 6605   | 7740 | 6536           | 6605   | 8340 |
| SENT2408H | 2400      | 80       | 1430                  | 1659   | 1850 | 1478           | 1659   | 1901 | 1627           | 1659   | 2064 |
| SENT2412H | 2400      | 125      | 2669                  | 3096   | 3456 | 2798           | 3096   | 3600 | 3058           | 3096   | 3878 |
| SENT2417H | 2400      | 175      | 3768                  | 4371   | 4867 | 4092           | 4371   | 5268 | 4618           | 4371   | 5902 |
| SENT2422H | 2400      | 225      | 4927                  | 5715   | 6386 | 5287           | 5715   | 6821 | 5825           | 5715   | 7438 |
| SENT2427H | 2400      | 275      | 6211                  | 7205   | 8050 | 6545           | 7205   | 8443 | 7130           | 7205   | 9098 |
| SENT2608H | 2600      | 80       | 1550                  | 1798   | 2005 | 1602           | 1798   | 2059 | 1763           | 1798   | 2236 |
| SENT2612H | 2600      | 125      | 2891                  | 3354   | 3744 | 3032           | 3354   | 3900 | 3312           | 3354   | 4202 |
| SENT2617H | 2600      | 175      | 4082                  | 4735   | 5273 | 4433           | 4735   | 5707 | 5002           | 4735   | 6393 |

## Connection configurations

### Pipework and valve connection

The available connection configurations are shown below. All connections are R $\frac{1}{2}$ .











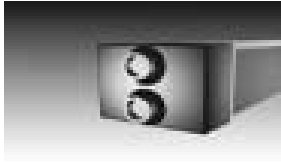

|                            |   |  |  |
|----------------------------|---|--|--|
| Configuration A            |    |    | VBSE (Vertical Bottom Same End)                |
| Configuration B (Standard) |    |    | TBSE (Top Bottom Same End)                     |
| Configuration C            |    |    | VBBA (Vertical Bottom Both End)                |
| Configuration D            |   |   | CBE (Centre Both End)                          |
| Configuration E            |  |  | VBTOE (Vertical Bottom & Top Bottom Other End) |
| Configuration F            |  |  | TBBE (Top Bottom Both Ends)                    |
| Configuration G            |  |  | SCOE (Single Centre One End)                   |

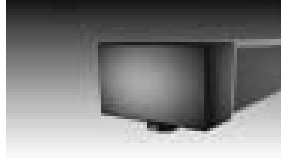
Fig 3 Connection configurations

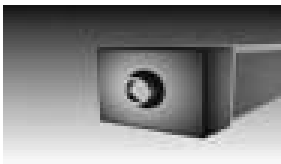
Please note that standard configuration B, highlighted in Fig 3, would be used with the Herz valves supplied by Clyde.

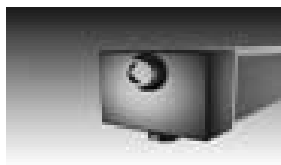
## Installation

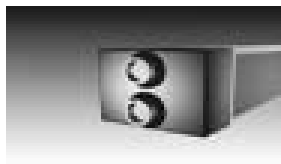
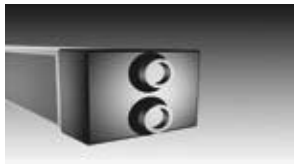
---

### Preliminary

Before unpacking, please ensure that the delivered sizes and quantity are correct. Any shortages or damages must be notified to Clyde in writing within 7 days.

Unpack carefully and inspect the convector, cover and fittings. The following items should be identified;

- Convector
- Casing with selected valve head cut-outs and grille
- Brackets and hanging straps. The number of these is dependent upon the convector dimensions.
- Air vent
- Herz valve, TRV thermostatic valve head and changefix spanner if ordered

Fig 4 below is a diagram of the Sentry. Refer to figs 1 and 2 on page 2 for bracket fixing dimensions and pipe centres.

### Installation

The Sentry LST is quick and easy to install, as shown in the six steps on page 9. The convector can be installed and connected to the system during first fix, and the cover and TRV thermostatic control head fitted during second fix.

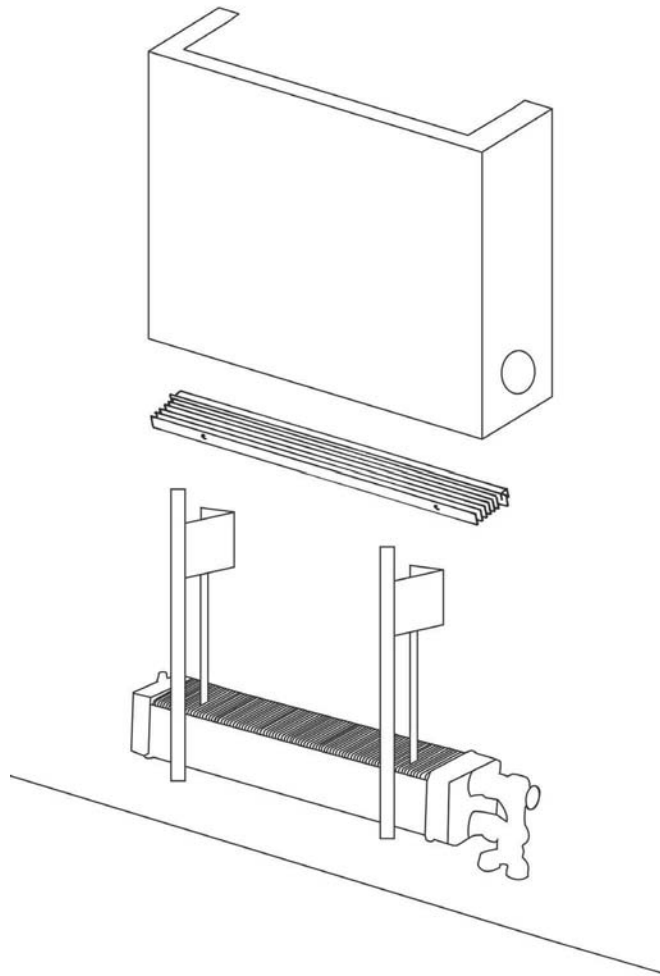

Fig 4 Sentry diagram

## Installation



### STEP 1

Measure and fit wall brackets using suitable fixings (not supplied).

Refer to figs 1 and 2 on page 2 for Fixing dimensions, minimum clearance above FFL and pipe centres



### STEP 2

Locate convector hanging brackets and valve body



### STEP 3

Hang convector onto wall brackets



### STEP 4

Connect pipework to valves



### STEP 5

Locate the top grille on the top of the wall brackets.  
Lift casing onto brackets and over the grille



### STEP 6

Fit selected valve head  
The optionally Available changefix spanner ensures ease of access

---

## LST performance

NHS Estates Health Guidance Note 'Safe' hot water and surface temperatures, 1998, states that 'wherever patients, residents and visitors have access, the maximum surface temperature of space heating devices should not exceed 43°C when the system is running at the maximum design output'. However, certain system design and operating parameters (eg a water flow temperature greater than 82°C) may increase the surface temperature of the LST. Contact Clyde's Technical Department for more specific advice regarding any project.

For an even higher level of protection, the Clyde *Centurion* range of LST has a cover that extends to floor level.

This publication is issued subject to alteration or withdrawal without notice. The illustrations and specifications are not binding in detail. All offers and sales are subject to the Company's current terms and conditions of sale, a copy of which is available on request.

---

**Clyde Energy Solutions Ltd**

Units 13 - 14 Charwoods Rd  
East Grinstead  
West Sussex RH19 2HU  
t : 01342 305550  
f : 01342 305560  
e : info@clyde4heat.co.uk  
w : clyde4heat.co.uk

EDS 811/1  
January 2010